



MODO PIN SPOT 85

MODO.PS085.15.BLK.BLK.27.38.

Recessed



Mounting	Recessed
Wattage	15W
Voltage	240V
Dimensions	(D) Ø85mm x (H) 105.5mm
Cut Out Dimensions	(D) Ø75mm
Finish	Black
Inner Trim Finish	Black
CCT	2700K
Beam Angle	38°
Material	Aluminium
IP Rating	IP20
UGR	<19
Luminous Flux	1275lm
CRI	>92+
Colour Deviation	<2 SDCM
Lifetime	50,000 hours
Warranty	5 years
Luminaires Type	Recessed
Driver	Remote

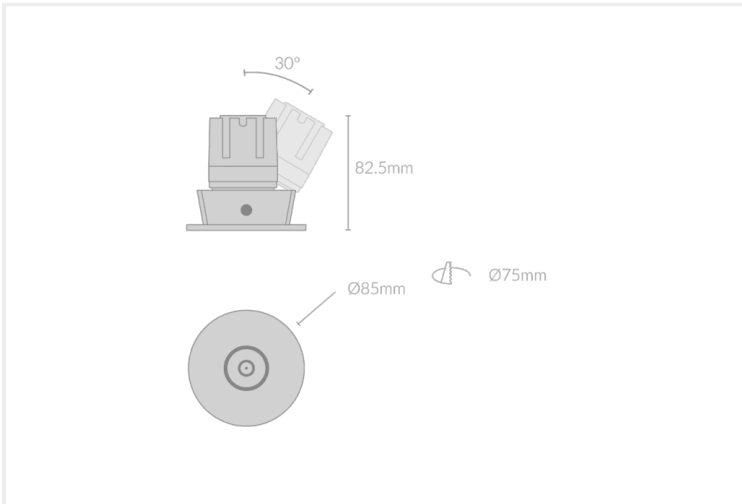

Control Gear

Accessories

MODO.PS085	15	BLK	BLK	27	38	
PRODUCT NAME	WATTAGE	FINISH	INNER TRIM FINISH	CCT	BEAM ANGLE	CONTROL GEAR