



SAI SPOT 106

SAI.S106.25.WHT.BLK.40.36.

Track Mounted



Mounting	Track 3-Circuit
Wattage	25W
Voltage	240V
Dimensions	(D) Ø106mm x (L) 85mm
Finish	White
Inner Trim Finish	Black
CCT	4000K
Beam Angle	36°
Material	Aluminium
IP Rating	IP20
Luminous Flux	2039lm
CRI	>92+
Colour Deviation	<2 SDCM
Lifetime	50,000 hours
Driver	Remote

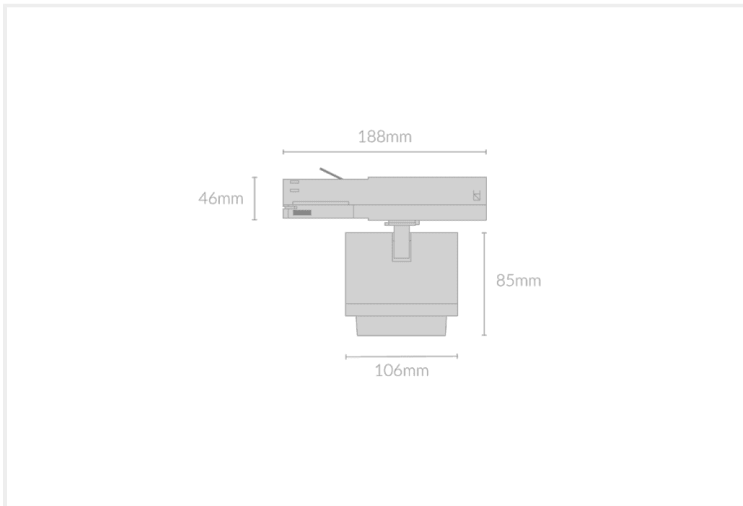

Control Gear

Accessories

