

MODO ANTI-GLARE TILT R165

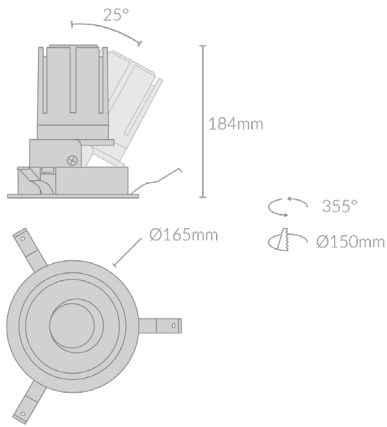

Specifications

Mounting	Recessed Mounting	Colour Deviation	<2 SDCM
Wattage	42W	Lifetime	50,000 hours
Voltage	240V	Adjustability	
Dimensions	(D) Ø165mm x (H) 184mm Cut Out - Ø150mm	Control Gear	TRIAC, DALI
Finish	Black/White	Warranty	5 years
Inner Trim Finish	Anthracite/Matte Silver/Matte White/Chrome/ Matte Black/Matte Gold/Custom		
CCT	2700K/3000K/3500K/4000K		
Beam Angle	15°/24°/38°/50°		
Material	Aluminum		
Driver	Remote		
IP Rating	IP20		
UGR	<19		
Luminous Flux	3570lm		
CRI	>92+		
Accessories	Honeycomb Lense, Soft Lense		

Product Accessories

Honeycomb Lens



Soft Lens



Product Code

Example: MODO.AGTR165.42.BLK.ATH.27.15.HCMB.TRIAC

Product	Wattage	Finish	Inner Trim	CCT	Beam Angle	Accessories	Control Gear
MODO.AGTR165	42(W)	BLK (Black) WHT (White)	ATH (Anthracite) MSV (Matte Silver) MWH (Matte White) CHM (Chrome) MBK (Matte Black) MGD (Matte Gold) CTM (Custom)	27 (00K) 30 (00K) 35 (00K) 40 (00K)	15(°) 24(°) 38(°) 50(°)	HCMB (Honeycomb Lens) SFLS (Soft Lens)	TRIAC (TRIAC) DALI (DALI)