

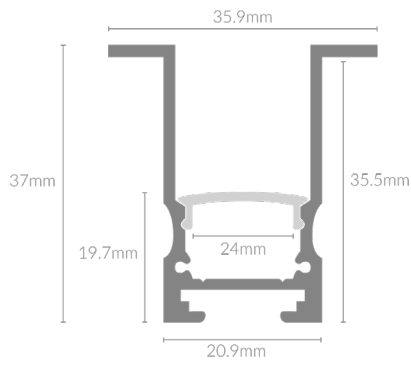

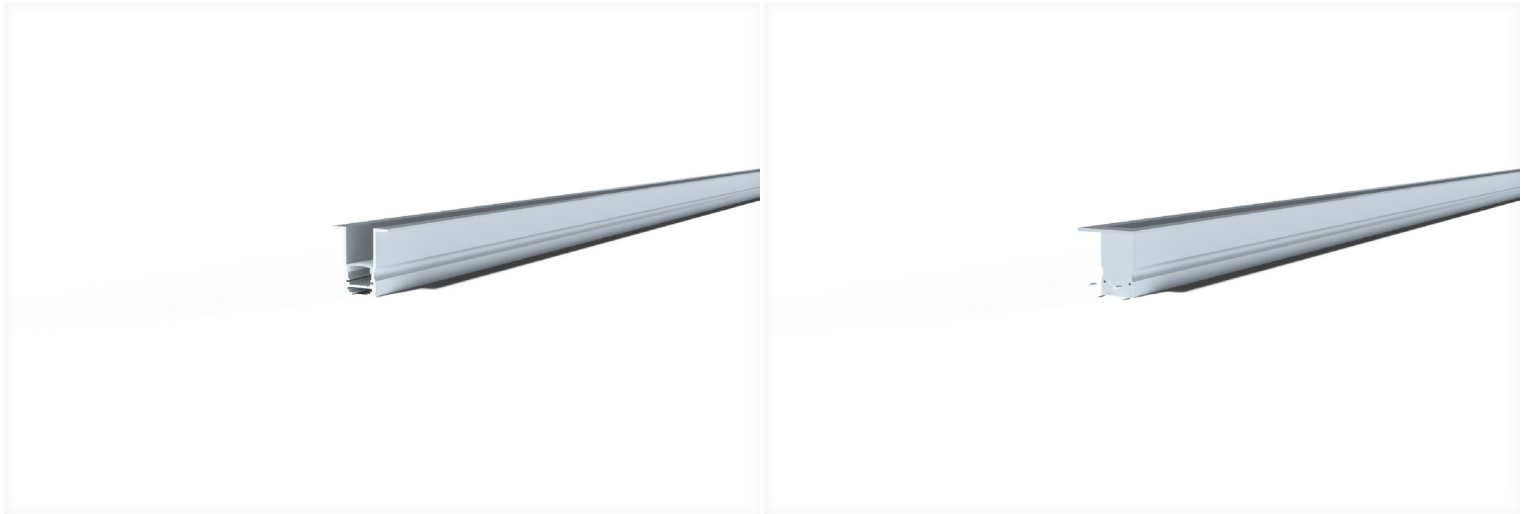



LP R3637

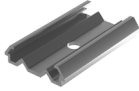

Specifications

Mounting	Recess Mounted
Dimensions	(W) 35.9mm x (H) 37mm
Length	2000mm,2500mm,3000mm
Finish	Anodized Aluminium,Custom Powdercoat
Extrusion Material	Anodized Aluminium
Diffuser Material	Polycarbonate
End Cap Material	Polycarbonate
Accessories	Profile Clip, Endcap, PC Diffuser, Black PC Diffuser, Joiner Plate
Warranty	3 years

Product Accessories

<p>Spring Clip</p> 	<p>End Cap</p> 	<p>PC Diffuser</p> 	<p>Black PC Diffuser</p> 
<p>Joiner Plate</p> 			

Product Code

Example - LP.R3637.2500.ANZ

Product Name

LP.R3637

Length

2000 (mm)

2500 (mm)

3000 (mm)

Finish

ANZ (Anodized)

CTM (Custom)

Product Accessory Code

Example - LP.R3637.SC

Product Name

LP.R3637

Accessories

SC (Spring Clip)

EC (End Caps)

PD (PC Diffuser)

BPD (Black PC Diffuser)

JP (Joiner Plate)