

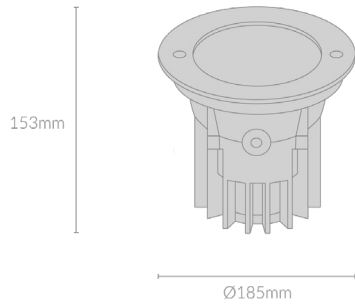

OUTDOOR



AME ADJUSTABLE UPLIGHT 185



Specifications

Mounting	Recessed Mounted	Control Gear	Non-dimmable, 1-10V Dimming, DALI
Wattage	18W	Warranty	5 years
Voltage	DC24V		
Dimensions	(D) Ø185mm x (H) 153mm		
Cut Out Diameter	Ø175mm		
Finish	Stainless Steel		
CCT	3000K/4000K		
Beam Angle	10°/15°/20°/36°		
Material	Stainless Steel 316 & Aluminium Body		
Driver	Remote		
IP Rating	IP67		
IK Rating	IK09		
Luminous Flux	1100lm		
CRI	>92+		
Colour Deviation	<3 SDCM		
Lifetime	50,000 hours		
Accessories	Honeycomb, Gimble Tool		

Product Accessories

Honeycomb Lense



Gimble Tool



Mounting Sleeve



(W) 230 x (H) 230 x (L) 203mm

Product Code

Example - AME.AU185.18.SSL.30.10.HCMB.NDM

Product	Wattage	Finish	CCT	Beam Angle	Accessories	Control Gear
AME.AU185	18(W)	SSL (Stainless Steel)	30 (00K) 40 (00K)	10(°) 15(°) 20(°) 36(°)	HCMB (Honeycomb Lense) GMBT (Gimble Tool)	NDM (Non-dimmable) 1-10V (1-10V Dimming) DALI (DALI)